

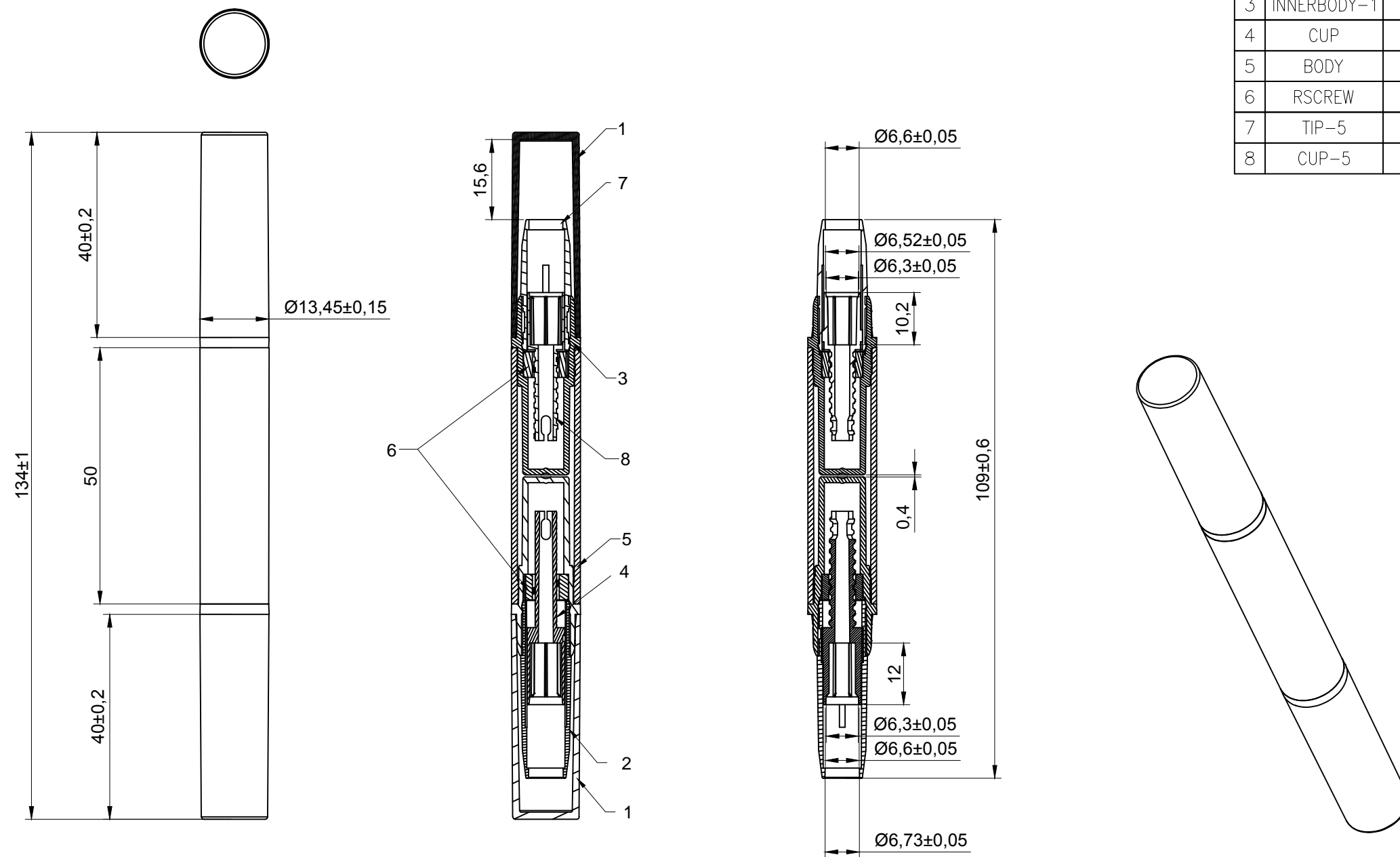
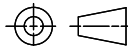

No.	NAME	Material	Drawing No.
1	CAP	ABS	D18093
2	TIP	ABS	D18094
3	INNERBODY-1	ABS	D18095
4	CUP	POK	D18096
5	BODY	ABS	D18097
6	RSCREW	POK	D18098
7	TIP-5	ABS	D18106
8	CUP-5	POK	D18107



4				CUSTOMER						
3				PART						ASSEMBLY
2				NAME	PEN	DESIGN	Wang	DATE	2018/10/26	
1	POM->POK;	WYF	2019/3/20	CODE	PP2020018	CHECKED		APPROVED		
NO.	REVISIONS DESCRIPTION	DRAWN	DATE	SCALE	1: 1		PLATE	A4	MATERIAL	--
	*Dim. are adjustable based on functional requirement	TOL.	±0.1mm	UNIT	mm [in]	DRAWING NO.	D18105	REV	00	